

Article number: 03440010

Description: Fluro Rod end GE 10EC

## Measures

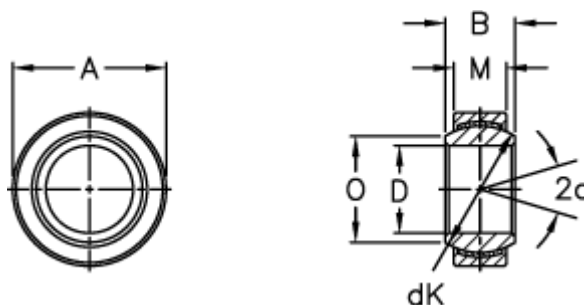

A	= 19 0 -0,009	Tilt angle = 12
B	= 9	Weight = 11
D	= 10 0 -0,008	
dK	= 16	
Dynamic load C (kN)	= 8.6	
M	= 6	
O	= 13.2	
Static load C0 (kN)	= 21.6	